

Gaggenau

en Information for Use

CX 482

Full surface induction cooktop

Table of contents

1	Safety	2
2	Avoiding material damage	4
3	Environmental protection and saving energy	5
4	Suitable cookware	5
5	Familiarising yourself with your appliance	7
6	Before using for the first time	9
7	Basic operation	9
8	Dynamic cooking	11
9	Professional cooking	12
10	Time-setting options	13
11	Booster for pots	14
12	Booster for pans	15
13	Keep-warm function	15
14	Transfer settings	15
15	Cooking sensor	16
16	Wireless cooking sensor	19
17	Dynamic cooking for an item of cookware	20
18	Teppanyaki function	21
19	Childproof lock	22
20	Pause function	22
21	Individual safety switch-off	23
22	Basic settings	23
23	Power limitation	24
24	Home Connect	24
25	Hob-based hood control	26
26	Cleaning and servicing	27
27	FAQs	27
28	Troubleshooting	30
29	Disposal	32
30	Declaration of Conformity	32
31	Customer Service	33

1 Safety

Observe the following safety instructions.

1.1 General information

- Read this instruction manual carefully.

- Keep the instructions, the appliance and the product information safe for future reference or for the next owner.
- Do not connect the appliance if it has been damaged in transit.

1.2 Intended use

Only a licensed professional may connect appliances without plugs. Damage caused by incorrect connection is not covered under the warranty.

The appliance can only be used safely if it is correctly installed according to the safety instructions. The installer is responsible for ensuring that the appliance works perfectly at its installation location.

Only use this appliance:

- To prepare meals and drinks.
- Under supervision. Never leave the appliance unattended when cooking for short periods.
- in private households and in enclosed spaces in a domestic environment.
- up to an altitude of max. 4000 m above sea level.

Do not use the appliance:

- With an external timer or a separate remote control. This does not apply if operation with appliances included in EN 50615 is switched off.

When using the cooking functions, set the hot-plate on which you have placed the saucepan with the temperature sensor.

If you wear an active implantable medical device (e.g. a pacemaker or defibrillator), check with your doctor that it complies with Council Directive 90/385/EEC of 20th June 1990, EN 45502-2-1 and EN 45502-2-2, and that it has been chosen, implanted and programmed in accordance with VDE-AR-E 2750-10. If these conditions are satisfied, and if, in addition, non-metal cooking utensils and cookware with non-metal handles are used, it is safe to use this induction hob as intended.

1.3 Restriction on user group

Do not let children play with the appliance.

Children must not perform cleaning or user maintenance unless they are at least 15 years old and are being supervised.

Keep children under the age of 8 years away from the appliance and power cable.

1.4 Safe use

⚠ WARNING – Risk of fire!

Leaving fat or oil cooking on an unattended hob can be dangerous and may lead to fires.

- ▶ Never leave hot oil or fat unattended.
- ▶ Never attempt to extinguish a fire using water; instead, switch off the appliance and then cover with a lid or a fire blanket.

The cooking surface becomes very hot.

- ▶ Never place flammable objects on the cooking surface or in its immediate vicinity.
- ▶ Never place objects on the cooking surface.

The appliance will become hot.

- ▶ Do not keep combustible objects or aerosol cans in drawers directly underneath the hob.

Hob covers can cause accidents, for example due to overheating, catching fire or materials shattering.

- ▶ Do not use hob covers.

After every use, switch off the hob using the main switch.

- ▶ Do not wait until the hob turns off automatically as there are no longer any pots and pans on it.

Food may catch fire.

- ▶ The cooking process must be monitored. A short process must be monitored continuously.

⚠ WARNING – Risk of burns!

The appliance and its parts that can be touched become hot during use, particularly the hob surround, if fitted.

- ▶ Caution should be exercised here in order to avoid touching heating elements.
- ▶ Young children under 8 years of age must be kept away from the appliance.

Hob protective grilles may cause accidents.

- ▶ Never use hob protective grilles.

The appliance becomes hot during operation.

- ▶ Allow the appliance to cool down before cleaning.

Metal objects on the hob quickly become very hot.

- ▶ Never place metal objects (such as knives, forks, spoons and lids) on the hob.

⚠ WARNING – Risk of electric shock!

Incorrect repairs are dangerous.

- ▶ Repairs to the appliance should only be carried out by trained specialist staff.
- ▶ Only use genuine spare parts when repairing the appliance.
- ▶ If the power cord or the appliance power cable of this appliance is damaged, it must be replaced with a special power cord or special appliance power cable, which is available from the manufacturer or its Customer Service.

If the appliance or the power cord is damaged, this is dangerous.

- ▶ Never operate a damaged appliance.
- ▶ If the surface is cracked, you must switch off the appliance in order to prevent a possible electrical shock. To do this, switch off the appliance via the fuse in the fuse box rather than at the main switch.
- ▶ Never pull on the power cord to unplug the appliance. Always unplug the appliance at the mains.
- ▶ If the appliance or the power cable is damaged, immediately switch off the fuse in the fuse box.
- ▶ Call customer services. → *Page 33*

An ingress of moisture can cause an electric shock.

- ▶ Do not use steam- or high-pressure cleaners to clean the appliance.

The insulation on cables of electrical appliances may melt if it touches hot parts of the appliance.

- ▶ Never bring electrical appliance cables into contact with hot parts of the appliance.

If metallic objects come into contact with the fan that is located on the underside of the hob, this may cause an electric shock.

- ▶ Do not store long, pointed metallic objects in the drawers below the hob.

⚠ WARNING – Risk of injury!

Saucepans may suddenly jump due to liquid between the saucepan base and the hotplate.

- ▶ Always keep hotplates and saucepan bases dry.
- ▶ Never use icy-cold cookware that has been in the freezer.

The wireless temperature sensor is equipped with a battery, which may become damaged if it is exposed to high temperatures.

- ▶ Remove the sensor from the cookware and store it away from any heat sources.

The temperature sensor may be very hot when removing it from the saucepan.

- ▶ Wear oven gloves or use a tea towel to remove it.

When cooking in a bain marie, the hob and cooking container could shatter due to overheating.

- ▶ The cooking container in the bain marie must not directly touch the bottom of the water-filled pot.

- ▶ Only use heat-resistant cookware.

An appliance with a cracked or broken surface can cause cuts.

- ▶ Do not use the appliance if it has a cracked or broken surface.

⚠ WARNING – Danger: Magnetism!

The wireless temperature sensor is magnetic and can damage electronic implants, e.g. heart pacemakers or insulin pumps.

- ▶ Persons with electronic implants must stand at least 10 cm away from the magnetic control element.
- ▶ Never put the control element in your pockets.

⚠ WARNING – Risk of suffocation!

Children may put packaging material over their heads or wrap themselves up in it and suffocate.

- ▶ Keep packaging material away from children.
- ▶ Do not let children play with packaging material.

Children may breathe in or swallow small parts, causing them to suffocate.

- ▶ Keep small parts away from children.
- ▶ Do not let children play with small parts.

2 Avoiding material damage

This is where you can find the most common causes of damage and tips on how to avoid them.

Damage	Cause	Measure
Stains	Unsupervised cooking process.	Monitor the cooking process.
Stains, blisters	Spilled food, especially food with a high sugar content.	Remove immediately with a glass scraper.
Stains, blisters or fractures in the glass	Defective cookware, cookware with melted enamel or cookware with copper or aluminium base.	Use suitable cookware that is in a good condition.
Stains, discolouration	Unsuitable cleaning methods.	Only use cleaning agents that are suitable for glass ceramic, and only clean the hob when it is cold.
Blisters or fractures in the glass	Knocks or falling cookware, cooking accessories or other hard or pointed objects.	When cooking, do not hit the glass or let objects fall onto the hob.
Scratches, discolouration	Rough cookware bases or moving the cookware on the hob.	Check the cookware. Lift the cookware when moving it.
Scratches	Salt, sugar or sand.	Do not use the hob as a work surface or storage space.
Damage to the appliance	Cooking with frozen cookware.	Never use frozen cookware.
Damage to the appliance	Hot cookware on the control panel, the display panels or the hob frame.	Never place hot cookware on these areas.
Damage to the cookware or the appliance	Cooking without contents.	Never place or heat empty cookware on a hot cooking zone.
Glass damage	Melted material on the hot cooking zone or hot pot lid on the glass.	Do not place greaseproof paper or aluminium foil nor plastic containers or pot lids on the hob.
Overheating	Hot cookware on the control panel or on the frame.	Never place hot cookware on these areas.

ATTENTION!

A fan is located on the underside of this hob.

- ▶ If a drawer is located on the underside of the hob, do not store any small or pointed objects, paper or tea towels in it. These objects may be sucked in and damage the fan or impair the cooling.
- ▶ There must be a clearance of at least 2 cm between the contents of the drawer and the fan entry point.

3 Environmental protection and saving energy

3.1 Disposing of packaging

The packaging materials are environmentally compatible and can be recycled.

- ▶ Sort the individual components by type and dispose of them separately.

3.2 Saving energy

If you follow these instructions, your appliance will use less energy.

Select the cooking zone to match the size of your pan. Centre the cookware on the hob. Always place items of cookware inside the usable area of the cooking surface.

Tip: Cookware manufacturers often give the upper diameter of the saucepan. It is often larger than the base diameter.

- Unsuitable cookware or incompletely covered cooking zones consume a lot of energy.

Cover saucepans with suitable lids.

- Cooking without a lid consumes considerably more energy.

Lift lids as infrequently as possible.

- When you lift the lid, a lot of energy escapes.

Use a glass lid.

- You can see into the pan through a glass lid without having to lift it.

Use pots and pans with flat bases.

- Uneven bases increase energy consumption.

Use cookware that is suitable for the quantity of food.

- Large items of cookware containing little food need more energy to heat up.

Cook with only a little water.

- The more water that is contained in the cookware, the more energy is required to heat it up.

Turn down to a lower power level early on.

- If you use an ongoing power level that is too high, you will waste energy.

Product Information according (EU) 66/2014 can be found on the attached appliance pass and online on the product page for your appliance.



4 Suitable cookware

Cookware that is suitable for induction cooking must have a ferromagnetic base. This means that the cookware must be magnetic and be the recommended size. The hob uses the ferromagnetic diameter and material of the base of the cookware to automatically detect the position, size and shape of the cookware being used. Follow the cookware manufacturer's instructions.

Cookware with a base measuring 90 to 340 mm in diameter is suitable for use.

4.1 Size and characteristics of the cookware

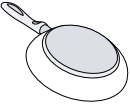
To be able correctly detect the cookware, you must take the size and the material of the cookware into consideration. All cookware bases must be perfectly flat and smooth.

Cookware	Materials	Properties
Recommended cookware	Stainless steel cookware in a sandwich design that distributes the heat well.	This cookware distributes the heat evenly, heats up quickly, and ensures that it can be detected easily.
	Ferromagnetic cookware made of enamelled steel, cast iron or special induction cookware made of stainless steel.	This cookware distributes the heat evenly, heats up quickly, and ensures that it can be detected.
Suitable	The base is not fully ferromagnetic.	If the ferromagnetic area is smaller than the base of the cookware, only the area that is ferromagnetic heats up. As a result, the heat is not distributed evenly.
		

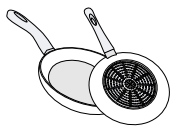

Cookware bases that contain aluminium.

These cookware bases reduce the ferromagnetic area, which means that less power is emitted to the cookware. This cookware may not be sufficiently detected or may not be detected at all, and therefore does not heat sufficiently.

Not suitable

Cookware made from normal thin steel, glass, clay, copper or aluminium.

Notes

- Do not use adapter plates between the hob and the cookware.
- Do not heat up empty cookware and do not use cookware with a thin base, as this may become very hot.

5 Familiarising yourself with your appliance

5.1 Cooking surface

The entire cooking surface of the hob supplies induction heating. Place the cookware on any position within the limits of the usable cooking surface. The hob automatically detects the position, size and shape of the cookware.

You can cook with up to five items of cookware on the cooking surface at the same time.

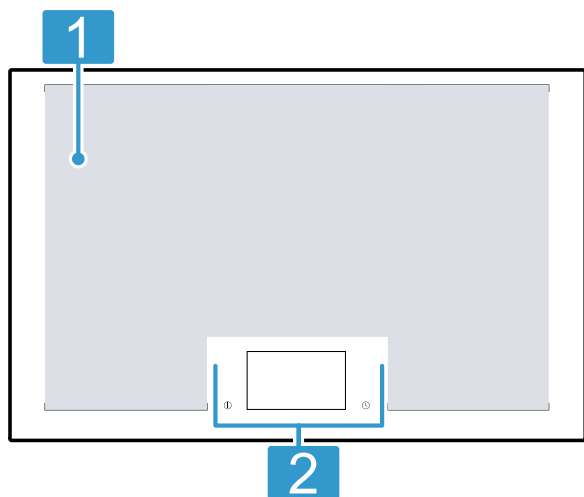

1 Usable cooking surface

2 Control panel

5.2 Control panel

Individual details, such as colour and shape, may differ from the figure.

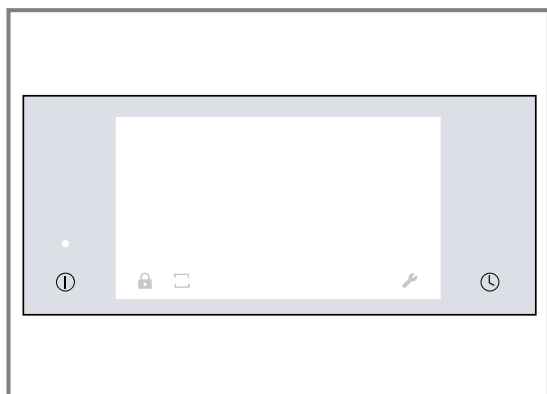

Notes

- Always keep the control panel clean and dry.
- Do not place any cookware near the displays or buttons. The electronics may overheat.

Touch buttons

When you switch on the hob, the symbols for the controls available at this time light up.

Button	Function
ⓘ	Main switch

Button	Function
ⓘ	Time menu <ul style="list-style-type: none"> ⌚ Timer ⌚ Runtime
🔒	Childproof lock
⏸	Pause function
☐	Hob operating modes <ul style="list-style-type: none"> 👤 Dynamic cooking 👤 Professional cooking 👤 Classic cooking
🔧	Basic settings
ⓘ	Hotplate <ul style="list-style-type: none"> 1...9 power levels ➤➤ Booster for pots ➤➤ Booster for pans 👤 Keep-warm function 🕒 Switch-off timer 👤 Operating modes for the cookware <ul style="list-style-type: none"> 👤 Dynamic cooking for an item of cookware 👤 Classic cooking for an item of cookware 👤 Cooking sensor 👤 Teppanyaki

Buttons in connection with Home Connect

As soon as the connection to Home Connect has been established, the following buttons are available:

Button	Function
📶	Connectivity
✚	Hob-based hood control
A	Ventilation control sensor
💡	Hood lighting

5.3 Touch display

You can use the touch display to operate the appliance simply and intuitively.

Main screen



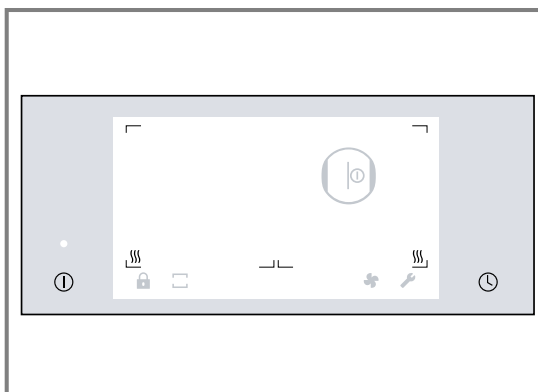

It shows the cookware on the cooking surface and the current settings for the active cooking zone, e.g. cooking mode, power levels and active time-setting options.



Function bar

Enables access to certain functions and additional menus.

The following options are shown in the function bar:

	Childproof lock
	Pause function
	Hob mode
	Hob-based hood control
	Basic settings

Info menu

You can call up information about the appliance and the current functions.

Opening the info menu

- ▶ Touch **i** in the function bar.
- ✓ The touch field is visible when the function is available.



Displays and notifications

- Notifications let the user know that the appliance's status has changed or tell them when they need to confirm something. The top line of the display lights up orange.
To return to the main view, touch ✓.
- The notifications make you aware that action is required. The top line of the display lights up blue. Follow the instructions on the display. To return to the main view, touch ✓.

Hob operating mode menu

The hob has various functions for the entire cooking surface.





Touch  in the function bar to call them up.

Symbol	Cooking mode	Function
	Professional cooking	Allows you to select the power level based on the position of the cookware on the cooking surface, from right to left.
	Classic cooking	Allows you to select the power level for the cooking zone.
	Dynamic cooking	Allows you to select the power level based on the position of the cookware on the cooking surface, from front to rear

Operating modes menu for the cookware



The hob has various operating modes for the cookware for the cooking zone.



To access them, touch the cooking zone display and then .



Symbol	Cooking mode	Function
	Dynamic cooking for an item of cookware	This enables you to control a certain power level according to the position of the cookware by moving the cookware from front to back over the cooking surface.
	Classic cooking for an item of cookware	This enables you to select the power level for each item of cookware.
	Cooking sensor	You can use the cooking sensor that is attached to the outside of the pan to automatically keep the temperature at a set level. These cooking functions are designed for foods that need to be cooked with a lot of water or fried with a lot of oil/fat in the pan.
	Teppanyaki	This means you can cook food on one section and keep food warm on the other section, or use the entire area to cook food at the same power level.

5.4 Cooking zone displays

When you place an item of cookware on the cooking surface, the indicator for the relevant cooking zone lights up in the touch display.

Hotplate	Status
	Detected cooking zone <ul style="list-style-type: none"> ■ The cookware on the cooking surface has been detected. ■ The hotplate indicator lights up. ■ Touch  to select the cooking zone.

Hotplate	Status
	Selected cooking zone <ul style="list-style-type: none"> ■ The displayed cooking zone has been selected. ■ You can set the power level.
	Cooking zone that is switched on <ul style="list-style-type: none"> ■ The displayed cooking zone is switched on. ■ The selected power level lights up on the display.

Hotplate	Status
	<p>No cookware on the cooking zone</p> <ul style="list-style-type: none"> You have removed the cookware from the cooking surface. The power level that was previously selected lights up less intensely.
	<p>Other displays</p> <ul style="list-style-type: none"> You cannot set the selected cooking zone. For more information, touch ⊖. <p>Possible causes:</p> <ul style="list-style-type: none"> Up to five items of cookware evenly distributed over the cooking surface can be heated at the same time. The cookware is not suitable for use on an induction hob. The appliance has exceeded its maximum power consumption.

Note: The cooking zone displays may show a different size or shape to the cookware actually being used. This is normal and does not affect the functioning of the hob.

5.5 Residual heat indicator

The cooking zone has several residual heat indicators that indicate that the cooking surface is still hot. One, two or all three indicator lines light up))) depending on the intensity of the residual heat. Do not touch the cooking surface while the indicators are still lit or immediately after they have switched off. The residual heat indicators will remain lit for as long as the cooking surface is still hot, even if you switch off the cooking surface.

6 Before using for the first time

Observe the following recommendations.

6.1 Initial cleaning

Remove any leftover packaging from the hob surface and wipe the surface with a damp cloth. You can find a list of recommended detergents on the official website www.gaggenau.com.

More information on care and cleaning. → Page 27

6.2 Cooking with induction

In comparison to conventional hobs, induction technology brings with it a series of changes and has a number of benefits such as time savings when cooking and frying, energy savings as well as greater ease of cleaning and care. It also offers improved heat control as the heat is generated directly in the cookware.

6.3 Cookware

You can find a list of recommended cookware on the official website www.gaggenau.com. Further information on suitable cookware.

6.4 Initial start-up

When you switch on the appliance for the first time, the standard language setting appears on the display as a first step to configure the hob.

You can change these settings at any time in the basic settings. → Page 23

6.5 Setting Home Connect

To start the connection settings, select the Home Connect setting in the basic settings and follow the instructions in the section entitled → "Home Connect", Page 24.

7 Basic operation

7.1 Switching the hob on

- ▶ Touch ⊕.
A signal tone sounds and the touch display lights up.
- ✓ The hob is ready to use.

Reactivate

- ▶ If you switch the appliance on within 10 seconds of switching it off, the hob operates with the settings that were previously set. You can activate this function in the basic settings. → Page 23

7.2 Switching the hob off

- ▶ Touch ⊕ until the displays go out.
- ✓ All cooking zones are switched off.

Note: If all of the cooking zones are switched off for longer than 30 seconds, the hob is automatically switched off.

7.3 Setting the power level in the cooking zones

The cooking zone has 17 power levels, which are displayed from 1 to 9 with intermediate values. Select the best power level for the food and the planned cooking process.

Requirement: The hob must be switched on.

1. Place the cookware on the cooking surface.
 2. Touch the required cooking zone display.
- ✓ The settings area for the cooking zone that you have selected appears on the display.

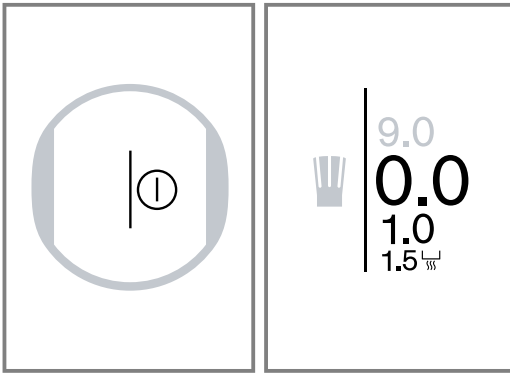

3. Swipe your finger over the settings area and touch the power level that you require.

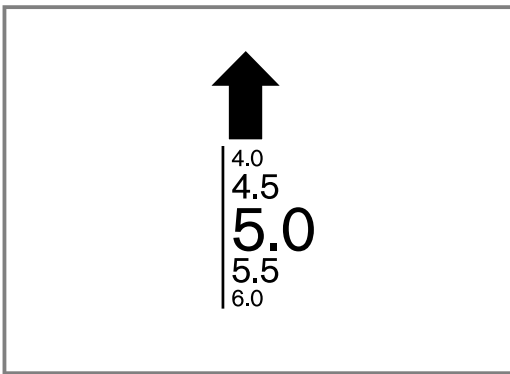

- ✓ The power level has been set.

7.4 Cooking tips

- When heating up puree, cream soups or thick sauces, stir occasionally.
- To preheat, set the power level 8-9.
- When cooking with the lid on, reduce the power level as soon as you see steam escaping. The cooking result is not affected by the steam escaping.
- After cooking, place a lid on the cookware until you serve the dish.
- To cook with the pressure cooker, observe the manufacturer's instructions.
- Do not cook food for too long, otherwise nutrients will be lost. The kitchen timer enables you to set the optimal cooking time.
- Ensure that the oil does not smoke.
- To brown the food, fry it in small portions, one after the other.
- Some items of cookware may reach high temperatures while the food is cooking. You should therefore use oven gloves.
- You can find recommendations for energy-efficient cooking under → "Saving energy", Page 5

Cooking recommendations

The table shows which power level (☰) is suitable for which food. The cooking time (⌚ min) may vary depending on the type, weight, thickness and quality of the food.

QuickStart

- ▶ If you place cookware on the cooking surface before you switch on the appliance, it is detected when the main switch is pressed and the cooking zone display appears on the touchscreen.

Changing the power level and switching off the cooking zone

1. Select the cooking zone.
 2. Select the required power level or set it to 0 in the settings area.
- ✓ The cooking zone's power level changes or the cooking zone switches itself off and the residual heat indicator appears.

No cookware/cookware of an unsuitable size

Requirement: Always place items of cookware inside the usable area of the cooking surface.

- ▶ If the cookware is not positioned correctly or is not the right material or the right size, ⊖ is displayed next to the cooking zone display. Move the cookware or use different cookware. If you remove the active cookware from the cooking surface for more than 30 seconds, the hotplate automatically switches off.

Switching off the cooking zone quickly

- ▶ If you press and hold the cooking zone display on the main display for a few seconds, the power level is set automatically to 0.0. You can switch this function off in the basic settings. → Page 23

	☰	⌚ min
Melting		
Chocolate coating	1 - 1.5	-
Butter, honey, gelatine	1 - 2	-
Heating and keeping warm		
Stew, e.g. lentil stew	1.5 - 2	-
Milk ¹	1.5 - 2.5	-
Boiled sausages ¹	3 - 4	-
Defrosting and heating		
Spinach, frozen	3 - 4	15 - 25
Goulash, frozen	3 - 4	35 - 55
Poaching, simmering		
Potato dumplings ¹	4.5 - 5.5	20 - 30
Fish ¹	4 - 5	10 - 15
White sauces, e.g. Béchamel sauce	1 - 2	3 - 6
Whisked sauces, e.g. Béarnaise sauce, Hollandaise sauce	3 - 4	8 - 12
Boiling, steaming, braising		
Rice, with double the volume of water	2.5 - 3.5	15 - 30
Rice pudding	2 - 3	30 - 40
Unpeeledboiled pots	4.5 - 5.5	25 - 35

¹ Without lid

		⌚ min
Boiled potatoes	4.5 - 5.5	15 - 30
Pasta ¹	6 - 7	6 - 10
Stew	3.5 - 4.5	120 - 180
Soups	3.5 - 4.5	15 - 60
Vegetables	2.5 - 3.5	10 - 20
Vegetables, frozen	3.5 - 4.5	7 - 20
Stew in a pressure cooker	4.5 - 5.5	-
Stewing		
Rolled roasting joint	4 - 5	50 - 65
Pot roast	4 - 5	60 - 100
Goulash	3 - 4	50 - 60
Braising/frying with a small amount of fat ¹		
Escalope, plain or breaded	6 - 7	6 - 10
Escalope, frozen	6 - 7	6 - 12
Chops, plain or breaded	6 - 7	8 - 12
Steak (3 cm thick)	7 - 8	8 - 12
Poultry breast (2 cm thick)	5 - 6	10 - 20
Poultry breast, frozen	5 - 6	10 - 30
Rissoles (3 cm thick)	4.5 - 5.5	20 - 30
Hamburgers (2 cm thick)	6 - 7	10 - 20
Fish and fish fillet, plain	5 - 6	8 - 20
Fish and fish fillet, breaded	6 - 7	8 - 20

¹ Without lid

		⌚ min
Fish, breaded and frozen, e.g. fish fingers	6 - 7	8 - 15
Prawns and scampi	7 - 8	4 - 10
Sautéing fresh vegetables and mushrooms	7 - 8	10 - 20
Stir-fry, vegetables, meat cut in strips Asian-style	7 - 8	15 - 20
Frozen dishes, e.g. stir-fries	6 - 7	6 - 10
Pancakes, cooked one after the other	6.5 - 7.5	-
Omelette (cooked one after the other)	3.5 - 4.5	3 - 10
Fried eggs	5 - 6	3 - 6
Deep-frying, 150–200 g per portion in 1–2 l oil, deep-fat fried in portions ¹		
Frozen products, e.g. chips, chicken nuggets	8 - 9	-
Croquettes, frozen	7 - 8	-
Meat, e.g. chicken portions	6 - 7	-
Fish, breaded or battered	6 - 7	-
Vegetables, mushrooms, breaded, beer-battered or tempura	6 - 7	-
Small baked items, e.g. doughnuts, battered fruit	4 - 5	-

¹ Without lid

8 Dynamic cooking

You can use this function in particular for cooking processes for which you frequently change the power level. During the cooking process, adjust the power level quickly and conveniently by moving the cookware forwards or backwards.

If you activate this function, the entire cooking surface is converted into a single cooking area with three different power levels. Depending on the position of the cookware, the appliance activates the respective preset power level.

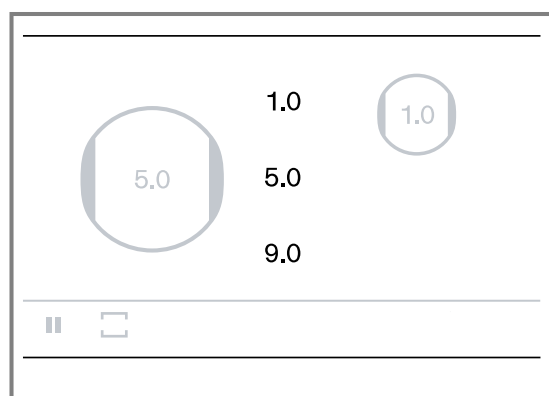

Notes

- If the dynamic cooking function is active, the following functions are not available:
 - Booster for pots
 - Booster for pans
 - Keep-warm function
 - Operating modes for the cookware
 - Switch-off timer
- If you move the cookware on the cooking surface, the hob automatically starts searching. The power level is set for the area on which the cookware is detected.
- Further information on the size and positioning of cookware can be found in the chapter entitled "Suitable cookware." → Page 5



8.1 Preset power levels

The power level that is assigned to each item of cookware appears in the relevant cooking zone display.

Area	Power level
Front area	9.0
Middle area	5.0
Rear area	1.0



You can change the preset power levels in the basic settings. → Page 23



8.2 Activating dynamic cooking

1. Touch .
 2. Touch .
 3. Touch  to confirm the selection.
- ✓ The preset power levels are displayed on the main screen.

8.3 Setting down the cookware

Note: If there is an active item of cookware on the cooking zone before you activate the function, the cooking zone display appears without a power level.

1. Touch the cooking zone display to confirm the assigned power level.
2. Press .
3. If a new item of cookware is set down, touch the cooking zone display.
4. Press .

Note: If the cookware is not the right size for this function, the  symbol lights up on the cooking zone display. For information, touch . To return to the main view, touch .



8.4 Changing the power level

You can change the power levels while you are cooking.

1. Touch the power level to be changed.
2. Select another power level in the settings area.

Note: If you deactivate the function, the power levels return to the preset values.

8.5 Deactivating dynamic cooking

1. Touch .
2. Select another operating mode for the hob.
3. Touch  to confirm the selection.
The power levels that are assigned to the respective cookware are retained.

9 Professional cooking

You can use this function in particular for cooking processes for which you frequently change the power level. During the cooking process, adjust the power level quickly and conveniently by moving the cookware to the left or right.

If you activate this function, the entire cooking surface is converted into a single cooking area with three different power levels. Depending on the position of the cookware, the appliance activates the respective preset power level.

Notes

- If the professional cooking function is activated, the following functions are not available:
 - Booster for pots
 - Booster for pans
 - Operating modes for the cookware
 - Switch-off timer
- Further information on the size and positioning of cookware can be found in the chapter entitled "Suitable cookware." → Page 5

9.1 Preset power levels

The power level that is assigned to each item of cookware appears in the relevant cooking zone display.

Area	Power level
Left-hand area	1.5
Middle area	9.0
Right-hand area	5.0

You can change the preset power levels in the basic settings. → Page 23



9.2 Activating the professional cooking



1. Touch .
2. Touch .

3. Touch  to confirm the selection
- ✓ The preset power levels are displayed on the main screen.

9.3 Setting down the cookware

Note: If there is an active item of cookware on the cooking zone before you activate the function, the cooking zone display appears without a power level.

1. Touch the cooking zone display to confirm the assigned power level.
2. Press .
3. If a new item of cookware is set down, touch the cooking zone display.
4. Press .

Note: If the cookware is not the right size for this function, the  symbol lights up on the cooking zone display. For information, touch . To return to the main view, touch .

9.4 Combining areas

The areas with the preset power levels can be combined to form one large surface with the same power level.

1. To do this, touch one of the vertical edges of the middle area and swipe left or right with your finger to the end of the adjacent area.



- ✓ The power level of the combined area is the same as the power level of the area being expanded.

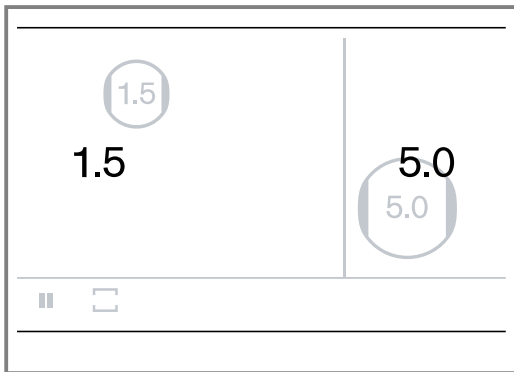

2. To separate the combined areas again, touch one of the vertical edges of the area and swipe left or right with your finger until the hidden section reappears.

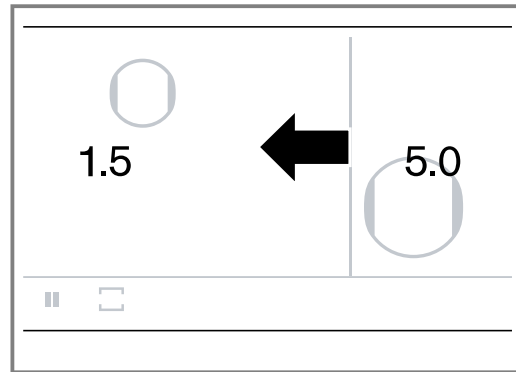



9.5 Changing the power level

You can change the power levels while you are cooking.

1. Touch the power level to be changed.
2. Select another power level in the settings area.

Note: If you deactivate the function, the power levels return to the preset values.

9.6 Deactivating professional cooking

1. Touch .
2. Select another operating mode for the hob.
3. Touch  to confirm the selection.
The power levels that are assigned to the respective cookware are retained.

10 Time-setting options

Your hob has various functions for setting the cooking time:



- Switch-off timer
- Timer
- Runtime

10.1 Switch-off timer

You can use this function to programme a cooking time for one or more cooking zones. The cooking zone is automatically switched off once the time that is set has elapsed.



You can set a cooking time of up to 12 hours 59 minutes.

Switching on Switch-off timer

1. Select the cooking zone and the power level.
2. Touch the selected power level.  lights up.
3. Press . 00 | 00:00 ^h/_{min}/_{sec} lights up in the cooking zone display.
4. Select the cooking time you require in hours and minutes.
5. Touch  to confirm.
 - ✓ The cooking time begins to elapse.
 - ✓ Once the cooking time has elapsed, the cooking zone is switched off and a signal sounds.

Note: When you set a cooking time for a cooking zone in which the Cooking sensor is activated, the cooking time will not start counting down until the selected temperature level has been reached.





Changing or switching off Switch-off timer

1. Press .
2. Touch  to confirm the set time.
3. Press  to cancel.

10.2 Timer

You can use this function to switch on a timer. This function operates independently of the cooking zones and other settings. It does not automatically switch off the cooking zones.

Setting the short-term timer

1. Press .
2. Select .
3. Touch  to confirm the selection.
 - ✓ The display 00 | 00.00 ^h/_{min}/_{sec} lights up.
4. Within the next 10 seconds, slide your finger up or down and set the required time. You can set hours, minutes and seconds.
5. Touch  to confirm the selected setting.
 - ✓  and the set time are shown in the function bar.

- ✓ The set time begins to count down.
- ✓ When the time has elapsed, a signal sounds.
- ✓ 00.00. flashes in the short-term timer display.
- 6. Press **⌘**.
- ✓ The displays go out and the signal tone stops.

Changing or deleting the short-term timer

1. Touch **⌘**.
2. Change the set time.
3. Touch **▶** to confirm the setting.
4. Touch **■** to delete the time.

Pausing the short-term timer

1. Press **⌘**.
2. Press **||**.
- ✓ The timer stops.
3. Touch **⌘** first and then **▶** to restart it.
- ✓ The kitchen timer starts again.

10.3 Runtime

The stopwatch function displays the time that has elapsed since activation.

Activating the stopwatch function

1. Press **⌚**.
2. Select **⌚**.
3. Touch **▶** to confirm the selection.
- ✓ The function bar shows 00.00 and **⌚**.
- ✓ The time starts to elapse.

Pause Runtime.

1. Touch **⌚** in the main view.
2. Touch **||**
- ✓ The stopwatch stops.
3. Touch **⌚** first and then **▶** to restart it.
- ✓ The stopwatch continues to run.

Deactivating the stopwatch function

1. Touch **⌚**.
2. Touch **■**.
- ✓ The stopwatch stops.
- ✓ 00.00 appears in the main view.
3. Touch **X** to exit the menu and return to the main view.

11 Booster for pots

This function allows large volumes of water to be heated up even more quickly than with power level 9. The booster function can be selected if **»»** lights up in the settings area for the cookware. The booster function for pots is only available for one pot on each side of the cooking surface.

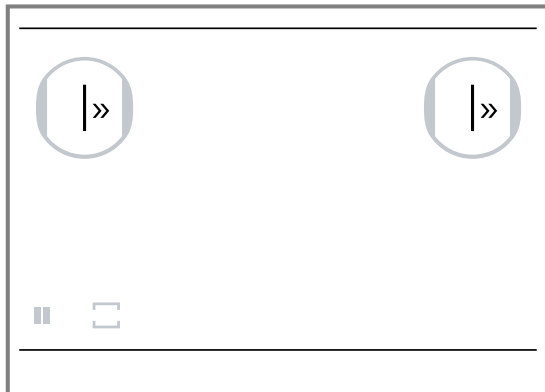

If the function is activated and you select a second cooking zone on the same side of the cooking surface, the appliance deactivates the function. The appliance automatically sets power level 9.0.



If the function is activated in the centre of the cooking surface, you can change the settings for other cookware on the right- and left-hand sides of the hob.

11.1 Activating the booster function for pots

1. Select the cooking zone.
2. Swipe your finger upwards until **»»** appears.
- ✓ The function is activated.

11.2 Switching off Booster for pots

1. Select the cooking zone.
2. Set a different power level in the settings area.
- ✓ The function is switched off.

Note: In certain circumstances, this function may Booster for pots switch off automatically in order to protect the electronics components on the circuit board inside.

12 Booster for pans

You can use this function to heat up the cookware faster than with power level 9.0.

After deactivating the function, select the appropriate ongoing cooking setting for your food.

This function is available if the  symbol lights up in the settings area for the cookware. The function is only available for one item of cookware on each side of the cooking surface.

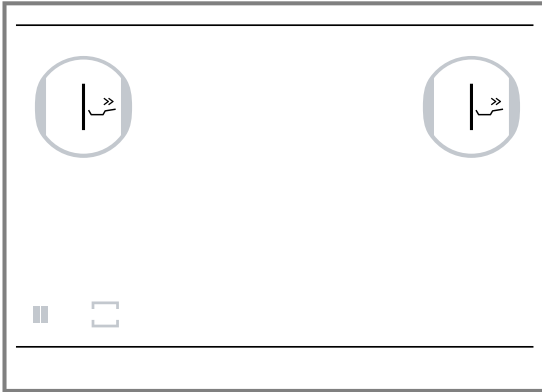

If you select settings for a different cooking zone on the same side of the cooking surface, the booster function is deactivated. The power level 9.0 is set automatically. If the function is activated in the centre of the cooking surface, you can implement the settings for other cookware on the right- and left-hand sides of the hob.

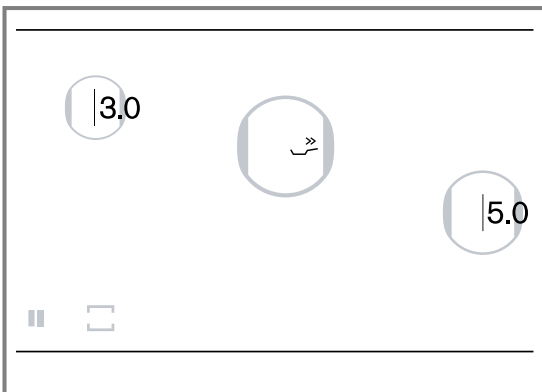

12.1 Recommended applications

- Only use cold cookware.
- Use cookware with a completely flat base. Do not use cookware with a thin base.
- Never heat up empty cookware or oil, butter or lard unattended.
- Do not place a lid on the cookware.
- You can find information on the type, size and positioning of the cookware in the Suitable cookware section. → Page 5

12.2 Switching on Booster for pans

1. Touch the cooking zone display.
 2. Select  in the settings area.
- ✓ The function is activated.

12.3 Deactivating the booster function for pans

- ▶ Touch the cooking zone display and select any power level in the settings area.
- ✓ The function is switched off.

Note: The frying pan booster function automatically switches off after 30 seconds and then automatically sets itself to power level 9.0.

13 Keep-warm function

You can use this function to melt chocolate or butter, and to keep meals warm.

13.1 Activating the keep-warm function

1. Select the cooking zone.
 2. Set the power level 1.5 .
- ✓ The function is activated.

13.2 Deactivating the keep-warm function

1. Touch the cooking zone display.
 2. Select any power level.
- ✓ The function is switched off.

14 Transfer settings

You can use this function to transfer the set power level or temperature level and the cooking time when you move the cookware on the cooking surface.

If you remove the cookware from the cooking surface or move it, the cooking zone no longer heats up.

The settings for the cooking zone are retained for 30 seconds.
When you place the cookware back in this position, the same settings are used.

14.1 Transfer settings

1. Place the cookware down at a different position on the cooking surface.

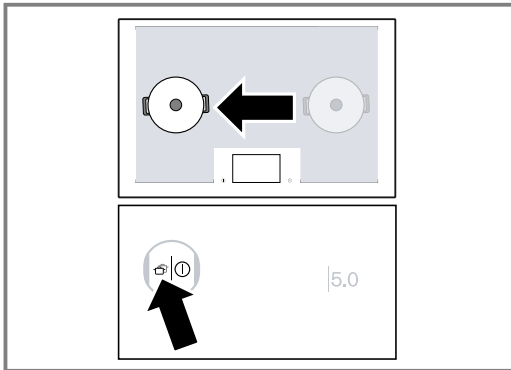

- ✓ The  lights up in the display of the new cooking zone.

2. Touch  to confirm the transfer of settings.
 - ✓ The power level is displayed in the new cooking zone.

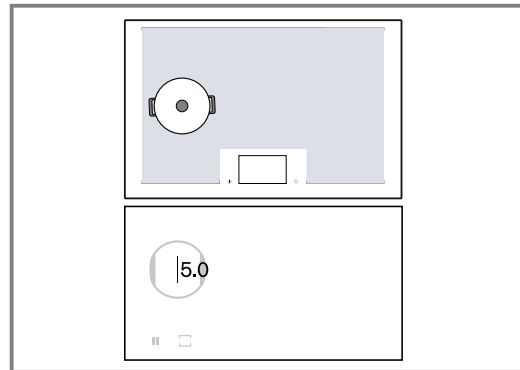







- ✓ The settings are transferred to the new cooking zone.

15 Cooking sensor

You can use this function to heat up, cook or boil foods, cook with the pressure cooker or fry in a pot with a lot of oil at a controlled temperature.
In order to use these functions, you need the wireless cooking sensor for wireless cooking.
This function is available for all cooking zones with the wireless cooking sensor on the normal cookware.

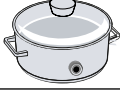
15.1 Temperature levels

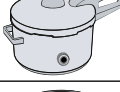
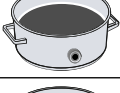
Temperature levels for preparing meals.

Level	Temperature	Functions	Cookware
1	70 °C	Heating and keeping warm	
2	85 °C	Poaching in milk	
3	90 °C	Poaching in water	
4	100 °C	Boiling	
5	115 °C	Cooking in a pressure cooker	
6	160 °C	Deep-fat frying in an immersion bath at a low temperature	
7	170 °C	Deep-fat frying in an immersion bath at a medium temperature	



Level	Temperature	Functions	Cookware
8	180 °C	Deep-fat frying in an immersion bath at a high temperature	



15.2 Notes on the Cooking sensor function

- The wireless cooking sensor measures the temperature of the liquid through the silicone base attached to the container. To ensure correct measurement, the silicone base must be completely covered by the liquid to be measured.
- The frame of the wireless cooking sensor and the silicone base fitted on the cookware must be completely dry before you can start cooking.
- Do not remove the wireless cooking sensor during cooking. After cooking, remove the sensor carefully as the sensor may be hot.
- To save energy, use a lid.
- Position the cookware in such a way that the wireless cooking sensor is pointing towards the outer side of the hob.
- To prevent overheating, never align the cooking sensor to any other hot cookware.



15.3 Switching on Cooking sensor

Requirement: Connect the wireless cooking sensor.

1. Attach the wireless cooking sensor to the cookware.
2. Place cookware filled with sufficient liquid on the required cooking zone and put the lid on.
3. Select the cooking zone on which you have placed the cookware with the wireless cooking sensor.
4. Touch the  symbol.
5. Swipe your finger upwards and select  Cooking sensor.

6. Then touch the centre of the wireless cooking sensor.
7. Select the corresponding temperature level for the food you want to cook. The temperature symbol  next to the cooking zone lights up in stages until the selected temperature has been reached. Then a signal sounds and the temperature symbol goes out.
 - ✓ The function is activated.
 - ✓ The temperature level and  light up. The temperature display lights up increasingly red until the required temperature level has been reached. A signal sounds.
8. Once the signal tone has sounded, remove the lid and add the food. Cook with the lid on.

15.4 Switching off Cooking sensor

1. Tap the temperature level.
2. Touch  and select a different operating mode for the cookware.
 - ✓ Touch  to confirm.
 - ✓ The function is switched off.

15.5 Recommendations for cooking with Cooking sensor

The following table shows the ideal temperature levels for a selection of dishes. $\text{⌘}^{\circ}\text{C}$ and ⌚ min depend on the amount, condition and quality of the food.

Heating and keeping warm

	$\text{⌘}^{\circ}\text{C}$	⌚ min
Heating goulash	70	10-20
Heating mulled wine	70	5-15
Vegetables in cream sauce	70	15-20
Defrosting broths	70	15-25

- Poaching in milk

	$\text{⌘}^{\circ}\text{C}$	⌚ min
Potatoes		
Potato dumplings	85	30-40
Pasta and cereals		
Polenta	85	3-8
Semolina pudding	85	5-10
Desserts		
Rice pudding	85	40-50
Porridge	85	10-15
Chocolate pudding	85	3-5
Other		
Heating milk	85	3-10

Poaching in water.

	$\text{⌘}^{\circ}\text{C}$	⌚ min
Meat		
Sausages	90	10-20
Fish		
Braised fish	90	15-20
Pasta and cereals		

	$\text{⌘}^{\circ}\text{C}$	⌚ min
Rice	90	25-35
Parboiled rice	90	25-35
Brown rice	90	45-55
Exotic rice dishes (Basmati, Thai)	90	8-12
Wild rice	90	20-30
Quinoa	90	10-12
Soups		
Instant creams	90	10-15

- Bringing to the boil

	$\text{⌘}^{\circ}\text{C}$	⌚ min
Meat		
Meatballs	100	20-30
Chicken	100	60-90
Veal	100	60-90
Egg dishes		
Boiled eggs	100	5-10
Vegetables and legumes		
Broccoli	100	10-20
Cauliflower	100	10-20
Spinach	100	5-10
Brussels sprouts	100	30-40
Green beans	100	15-30
Chickpeas	100	60-90
Peas	100	15-20
Lentils	100	45-60
Potatoes		
Gnocchi	100	3-6
Potatoes, boiled	100	30-45
Sweet potatoes	100	30-45
Pasta and cereals		
Durum wheat pasta	100	7-10
Fresh pasta	100	3-5
Wholemeal pasta	100	7-10
Durum wheat pasta, stuffed	100	15-20
Fresh pasta, stuffed	100	5-8
Quinoa	100	10-12
Soups		
Home-made broths	100	60-90
Instant soups	100	5-10
Desserts		
Compote	100	15-25
Frozen products		
Green beans	100	15-30
Cooking in a pressure cooker		
	$\text{⌘}^{\circ}\text{C}$	⌚ min
Meat		
Chicken	115	15-25

	⌘ °C	⌚ min
Veal	115	15-25
Vegetables and legumes		
Vegetables	115	3-6
Chickpeas	115	25-35
Lentils	115	10-20
Beans	115	25-35
Potatoes		
Potatoes	115	10-20
Sweet potatoes	115	10-20
Pasta and cereals		
Rice	115	6-8
Brown rice	115	12-18
Soups		
Home-made broths	115	20-30

Deep-fry with a large amount of oil at a low temperature.

Use the lid to heat the oil, and remove it to fry the food.

	⌘ °C	⌚ min
Potatoes		
Patatas bravas	160	8-12
Desserts		
Jam-filled doughnuts and doughnuts	160	5-10

Deep-fry with a large amount of oil at a medium temperature.

Use the lid to heat the oil, and remove it to fry the food.

	⌘ °C	⌚ min
Meat		
Chicken pieces	170	10-15
Meatballs	170	10-15
Fish		
Fish, beer-battered or breaded	170	10-15
Vegetables and legumes		
Vegetables, beer-battered or breaded	170	4-8
Mushrooms, breaded or beer-battered	170	4-8

Deep-fry with a large amount of oil at a high temperature.

Use the lid to heat the oil, and remove it to fry the food.

	⌘ °C	⌚ min
Frozen products		
Chips	180	4-8



15.6 Wireless cooking sensor

To use Cooking sensor, you must purchase a wireless cooking sensor.





You can purchase the wireless cooking sensor from customer service, in our online shop or in a specialist shop www.gaggenau.com.



Connecting the wireless cooking sensor

To connect the wireless cooking sensor to the control panel, proceed as follows:



1. Touch  in the main view.
2. Select the "Pair cooking sensor" option and press  to confirm your choice.
3. Briefly touch the centre of the wireless cooking sensor within 30 seconds.
 - After a few seconds, the result of the connection between the cooking sensor and the control panel appears on the display.

Result

 Connected correctly	Cooking sensor is available.
 Not connected correctly	<p>Communication error</p> <ul style="list-style-type: none"> ▪ Repeat the connection process. If the result is still , contact customer service.
 Not connected correctly	<p>Communication error</p> <ul style="list-style-type: none"> ▪ Bluetooth communication error. Repeat the connection process. ▪ You have not touched the centre of the wireless cooking sensor within 30 seconds of selecting the cooking zone. Repeat the connection process. ▪ The battery in the wireless cooking sensor is flat. Replace the battery, reset the wireless cooking sensor and repeat the connection process.

4. Press  to confirm.
 - To connect another cooking sensor, touch the  symbol.
 - To return to the basic settings, touch **X**.
-  Once the cooking sensor has been connected to the control panel correctly, the cooking sensor is available.

Resetting the wireless cooking sensor

1. Press the centre of the cooking sensor for approx. 8 - 10 seconds.
 -  During this process, the LED display for the wireless cooking sensor lights up three times.
 -  When the LED lights up for the third time, it will start to reset the temperature sensor.
2. Now stop pressing the centre of the wireless cooking sensor.
 -  As soon as the LED goes out, this means that the wireless cooking sensor has been reset.
3. Repeat the connection process from point 2.

Setting the boiling point

The point at which water starts to boil depends on the height of your home above sea level. If the water is boiling too vigorously or not vigorously enough, you can adjust the boiling point. Proceed as follows: Select the "Set boiling point" setting in the basic settings. → Page 23

The default basic setting is 200–400 m. If your home is located at this height above sea level, do not set the boiling point. Select the setting that matches your home's height above sea level.

Note: Temperature 4/100 °C is sufficient to boil efficiently. For a more intensive boil, select a lower level.

Tip: If you want to set the temperature more precisely, you can increase or decrease this by 1 °C to 5 °C. To do this, touch the selected temperature and then select

✓. Then select the required temperature and press ✓ to confirm. To cancel and exit the menu, touch the X symbol.

16 Wireless cooking sensor

To use Cooking sensor, you must purchase a wireless cooking sensor.

You can purchase the wireless cooking sensor from customer service, in our online shop or in a specialist shop www.gaggenau.com.

16.1 Scope of delivery

After unpacking all of the parts, check for any transport damage and for completeness of delivery.

- **A** Wireless cooking sensor
- **B** Silicone patch
- **C** Template

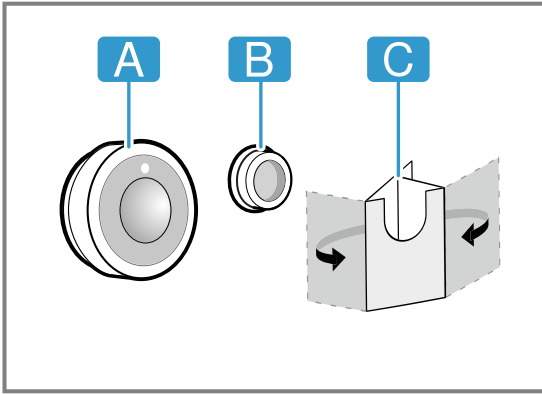

16.2 Attaching the silicone patch

The silicone patch secures the cooking sensor to the cookware. For fitting on the cookware:

1. The adhesive area on the cookware must be free from grease. Clean and dry the container thoroughly, and rub the adhesive area using alcohol, for example.
2. Remove the protective film from the silicone patch. Adhere the silicone patch to the outside of the cookware in the correct place using the enclosed template as a guide.

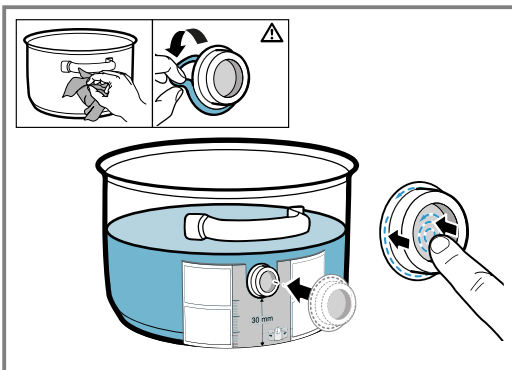

3. Press down all over the surface of the silicone patch, including in the centre.

4. Leave the adhesive to dry for one hour. Do not use or rinse out the cookware during this time.

Note: If the silicone patch comes loose, use a new one. If required, you can purchase a set with five silicone patches from specialist retailers, from our customer service or on our official website www.gaggenau.com by quoting the article number 17007119. All adhesives break down over time when they are stored. To prevent this from happening, place the silicone bases on their containers as soon as they are cleaned.

16.3 Attaching the wireless cooking sensor

1. Ensure that the silicone patch is completely dry before attaching the cooking sensor.
2. Attach the cooking onto the silicone patch so that it fits perfectly.

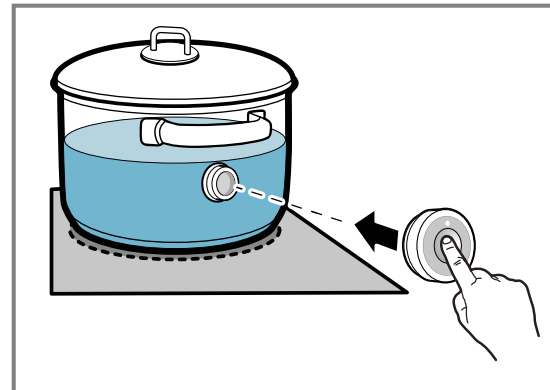

16.4 Replacing the battery

If the LED on the wireless cooking sensor does not light up when pressed, the battery is discharged. Changing the battery:

1. Remove the silicone cover from the lower section of the cooking sensor casing and remove both screws using a screwdriver.

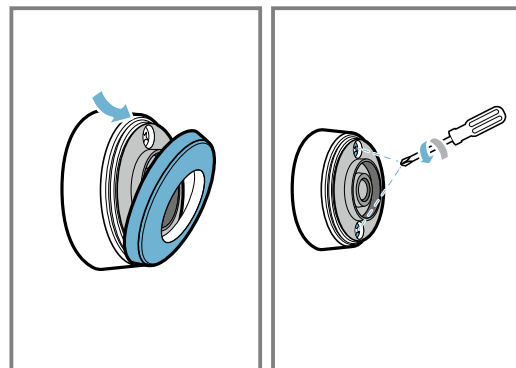

2. Open the cooking sensor lid and remove the battery from the base.

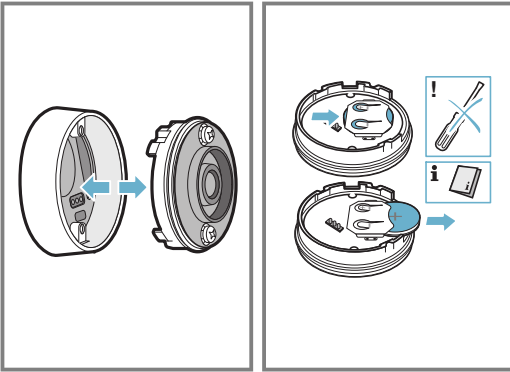

3. Insert a new battery, observing the instructions for the battery poles. Only use premium-quality CR2032 batteries.

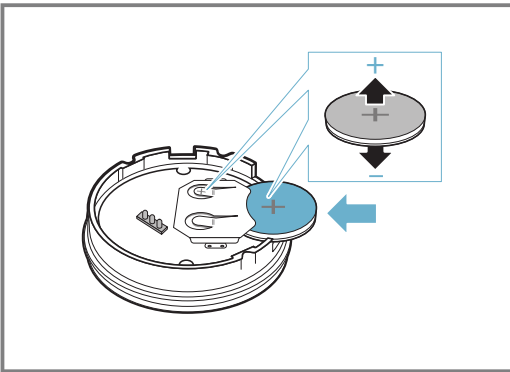

Note: Do not use any metal objects to remove the battery. Do not touch the battery connection points.

4. Close the cap on the cooking sensor. The indentations for the screws on the cap must be aligned with the indentations on the lower section of the housing. Use a screwdriver to tighten the screws and secure the silicone cover on the lower section of the cooking sensor housing.

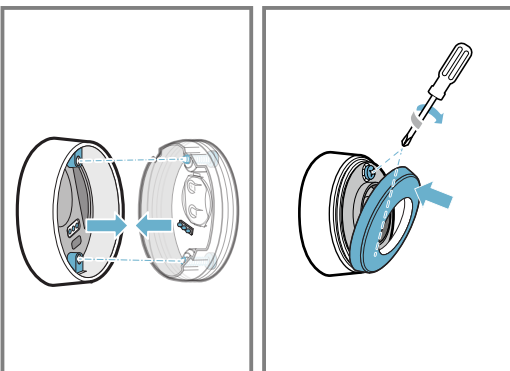

16.5 Cleaning

Cooking sensor

Clean with a damp cloth. Do not place in the dishwasher and do not get it wet.

When you are not using the cooking sensor, remove it from the cookware and store it in a clean, secure location, away from any heat sources.

Silicone patch

Clean and dry before attaching the cooking sensor. Dishwasher safe.

Note: The cookware with the silicone patch must not be left to soak for long periods in soapy water.

Window for the wireless cooking sensor

Always keep the window clean and dry. Important:

1. Remove dirt and oil splatters regularly.
2. For cleaning, use a cloth or a cotton bud and window-cleaning solution.

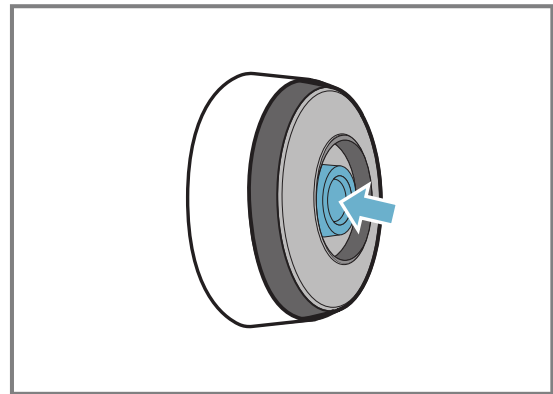

Notes

- Do not use hard or rough objects such as bristle brushes or scouring pads to clean the hob, and do not use scouring agents.
- Do not touch the window for the wireless cooking sensor with your fingers; this will soil or scratch it.

16.6 Declaration of Conformity

BSH Hausgeräte GmbH hereby declares that the appliance with wireless cooking sensor function meets the basic requirements and other relevant provisions of the Directive 2014/53/EU.

A detailed Declaration of Conformity in accordance with Directive RED can be found at www.gaggenau.com on the product page for your appliance under "Additional documents".

The logos and the Bluetooth® brand are registered trademarks and property of Bluetooth SIG, Inc. These trademarks are used by BSH Hausgeräte GmbH under licence. All other trademarks and trade names are owned by the respective companies.

17 Dynamic cooking for an item of cookware

Allows you to boil with preset power levels for an item of cookware that you place on the cooking surface. This enables the power level to be changed during cooking by sliding the cookware forwards or backwards. Preset power levels: 1.0, 3.0, 5.0, 7.0, 9.0.

You can change the preset power levels in the basic settings.

Notes

- If the function is not available, the cookware may be too large. In this case, use a smaller item of cookware.
- - If the function is not activated, the maximum power of the appliance may have been reached.
- Further information on the size and positioning of cookware can be found in the chapter entitled "Suitable cookware." → Page 5

17.1 Switching on dynamic cooking for an item of cookware

1. Place the cookware on the cooking surface.
2. Touch the cooking zone display for the cookware.
3. Press **▼**.
4. Swipe your finger down until  appears. Touch **✓** to confirm the selection.

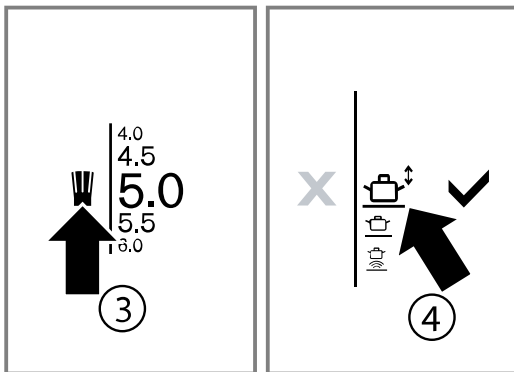

✓ The function is activated.

5. Move the cookware on the cooking surface until the cooking zone display shows the desired power level.

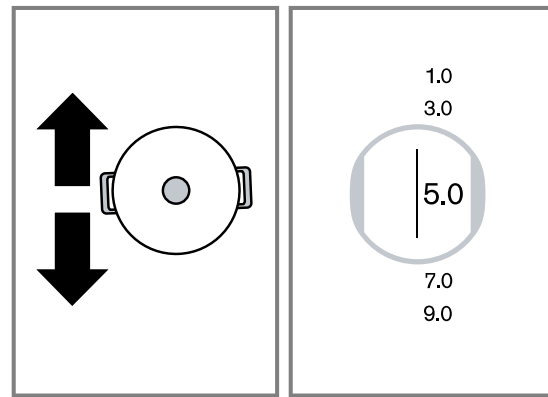
**17.2 Changing the power level**

You can change the power levels while you are cooking.

1. Touch the power level to be changed.
2. Select another power level in the settings area.

Note: If you deactivate the function, the power levels return to the preset values.

17.3 Switching off dynamic cooking for an item of cookware

1. Touch the power level display.
 2. Touch **▼** and select a different operating mode for the cookware.
 3. Touch **✓** to confirm.
- ✓ The function is switched off. The power level that was previously selected is retained.

18 Teppanyaki function

This mode allows you to split the surface of the teppanyaki into two halves: A hot area to which a power level is assigned, and an area to which no power level is assigned.

You can change the power levels while you are cooking.

Note: If this mode is not available in the settings area, check whether the cookware is too large. Use a smaller item of cookware.

18.1 Suitable cookware for teppanyaki

Suitable teppanyaki grill plates are available from specialist retailers, via our technical after-sales service or our official website.

Quote the relevant reference number:







- GN232110 griddle plate, dimensions 325 x 530 mm
- CA051300 griddle plate, dimensions 265 x 415 mm

18.2 Activating the teppanyaki function

1. Place the cookware on the cooking surface horizontally or vertically.
2. Touch the cooking zone display.

3. Press **▼**.
4. Slide your finger upwards until you reach the symbol for the teppanyaki grill.

The available symbols depend on the size of the teppanyaki grill and its position on the cooking surface.

Symbol	Position
	Vertical: Two cooking zones hot
	Vertical: Bottom cooking zone heated to medium heat
	Vertical: Top cooking zone heated with high heat
	Horizontal: Two cooking zones hot
	Horizontal: Right-hand cooking zone hot
	Horizontal: Left-hand cooking zone hot

5. Press ✓.

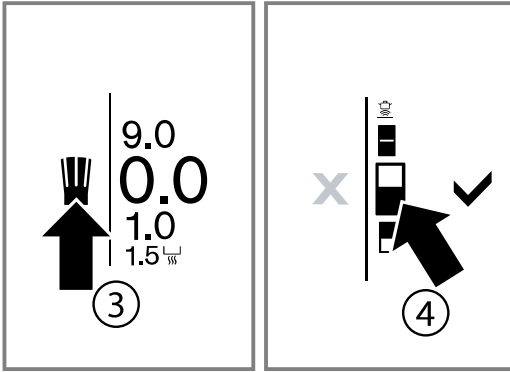

6. Select the required power level in the settings area.
 ✓ The alignment of the Teppanyaki grill with the selected power levels is shown in the display. If no power level is assigned to a cooking zone, ≡ appears.

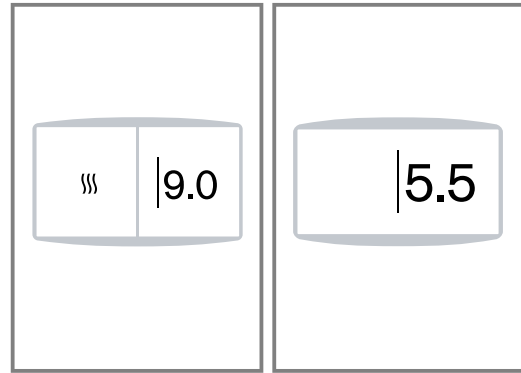

18.3 Changing the power level for the Teppanyaki function

1. Touch the set power level.
2. Use your finger to scroll up or down until you reach the required power level.

Note: If you change the position of the Teppanyaki, you can select the appropriate setting in the cooking zone display.

18.4 Deactivating the Teppanyaki function

1. Touch the power level.
2. Touch ≡ and select a different cookware mode in the settings area.
3. Touch ✓.

19 Childproof lock

The hob is equipped with a childproof lock. You can use this to prevent children from switching on the hob.

Note: If a hotplate is switched on, you cannot activate the childproof lock.

19.1 Activating the childproof lock

Requirement: The hob must be switched on.

- ▶ Touch and hold 🔒 for approx. four seconds.
- ✓ 🔒 lights up
- ✓ The hob is locked.

19.2 Deactivating the childproof lock

Requirement: The hob must be switched on.

- ▶ Touch and hold ⌫ for approx. four seconds.
- ✓ 🔒 lights up
- ✓ The lock is released.

19.3 Automatic childproof lock

This function automatically activates the childproof lock every time the hob is switched off.

Activating and deactivating

You can activate the automatic childproof lock in the basic settings. → *Page 23*

Note: To deactivate the automatic childproof lock, press and hold ⌫ for approx. four seconds.

20 Pause function

The selected settings are retained while the pause function is activated, but no power level is used and the cooking times that have been set will stop.

If you have activated the alarm or the timer, it will continue running. You cannot change the alarm time when the pause function is activated.

The lock has no effect on the main switch. You can switch off the hob at any time.

20.1 Switching on the pause function

- ▶ Press II.
- ✓ The hob remains locked for 30 minutes.
- ✓ Now you can clean the surface of the touch display without changing the settings.

20.2 Switching off the pause function

- ▶ To switch off the function before the 30 minutes have elapsed, first touch ▶ and then touch ✓ to confirm.

Notes

- If the function does not switch itself off, the hob switches off automatically after 30 minutes.
- If you move the cookware on the cooking surface while the function is activated, all the settings may be lost.

21 Individual safety switch-off

















The safety function is switched on if one cooking zone is in operation for an extended period and you do not change any settings. A message appears on the display and the cooking zone stops heating.

To switch off the display and reset the cooking zone, touch any button.
Touch . You can set the cooking zone again.

22 Basic settings

You can configure the appliance to meet your needs.



22.1 Overview of the basic settings

Symbol	Settings	Description and options
	Display brightness	Change the brightness of the touch display.
	Start screen	You can choose whether or not the brand logo will be displayed when you switch on the hob.
	Tones	You can set the warning tones that are emitted by the appliance.
	Power limitation	Restrict the hob's total power and adapt it to the local mains connection.
	Professional cooking	You can change the preset power levels for the cooking zones.
	Dynamic cooking	You can change the preset power levels for the cooking zones.
	Dynamic cooking for an item of cookware	You can change the preset power levels for the cooking zones.
CAL	Setting the boiling point	To adjust the boiling point, enter the height above sea level of your home.
	Connecting the cooking sensor	Establish the connection between the wireless cooking sensor and the hob.
	Temperature format	Change the temperature format.
	Language	Change the display language for the appliance.
	Start mode	Select the cooking mode that you want the hob to start with.
	Appliance number and production date	View information about the appliance.
	Automatic restore	Set how long the appliance saves the most recently used settings after it has been switched off.
	Presettings	You can restore all settings to the factory settings.
	Childproof lock	Disable the hob and prevent children from using it without supervision.
	Hob-based hood control	The ventilation system can be controlled from the hob either by connecting the appliances to your home network or by directly connecting the ventilation system to the hob.
	Home network	Set up the hob to automatically log into your home network via WPS, or you can do this manually.

22.2 Changing the basic settings

Requirement: All cooking zones are switched off.

1. Touch .
 - ✓ The basic settings menu is displayed.
 - ✓ The first option displayed is brightness.
2. Use your finger to scroll to the left or right in order to select a different option.

3. Touch  to change the setting.
4. Touch  to confirm the changes.
5. Touch  to discard the changes.

22.3 Exiting the basic settings

- ▶ Touch the main switch .

23 Power limitation

You can use this function to set the total power of the hob.

The hob is set at the factory. You can find the maximum power of the hob on the rating plate. You can use this function to adjust the configuration to the requirements of each electrical installation.

To ensure that this set value is not exceeded, the hob automatically distributes the available power as needed between the cooking zones that are switched on.

While the PowerManager function is activated, the output of a cooking zone may temporarily fall below the nominal value. If you switch on a cooking zone and the maximum power is reached, a corresponding message appears in the display. The appliance regulates and selects the highest power level automatically.

You can find out how to do this in the "Basic settings" section → *Page 23*

24 Home Connect

This appliance is network-capable. Connecting your appliance to a mobile device lets you control its functions via the Home Connect app, adjust its basic settings and monitor its operating status.

The Home Connect services are not available in every country. The availability of the Home Connect function depends on the availability of Home Connect services in your country. You can find information about this at: www.home-connect.com.

The Home Connect app guides you through the entire login process. Follow the instructions in the Home Connect app to configure the settings.

Tip: Please also follow the instructions in the Home Connect app.

Notes

- Please note the safety precautions in this instruction manual and make sure that they are also observed when operating the appliance via the Home Connect app.
→ "Safety", *Page 2*
- Operating the appliance on the appliance itself always takes priority. During this time it is not possible to operate the appliance using the Home Connect app.
- In networked standby mode, the appliance requires a maximum of 2 W.
- Hobs are not designed to be left unattended. Always monitor the cooking process.

24.1 Setting up the Home Connect app

1. Install the Home Connect app on your mobile device.

2. Start the Home Connect app and set up access for Home Connect.
The Home Connect app guides you through the entire login process.

24.2 Setting up Home Connect

Requirements





- The appliance is connected to the power supply and is switched on.
 - You have a mobile device with a current version of the iOS or Android operating system, e.g. a smartphone.
 - The Home Connect app has been installed on your mobile device.
 - The appliance is receiving signals from the WLAN home network (Wi-Fi) at its installation location.
 - The mobile device and the appliance are within range of your home network's Wi-Fi signal.
1. Open the Home Connect app and scan the following QR code.



2. Follow the instructions in the Home Connect app.









24.3 Overview of the Home Connect settings

You can adjust the settings and network settings for Home Connect by going to your hob's basic settings. The hob displays the setting "Connection" if the hob is not connected to the Wi-Fi. All other settings are only displayed if the hob is already connected to the Wi-Fi.

Symbol	Setting	Description and options
	Connection	You can switch the Wi-Fi network on or off.
	Connect to app	You can connect the hob to one or more Home Connect accounts.
	Set using the app	You can set whether the cooking settings from the Home Connect app can be sent to the hob.
	Deleting network settings	You can delete the saved connections to the Wi-Fi.

24.4 Wi-Fi symbols

The Wi-Fi indicator on the main control panel changes depending on the status of the connection and the availability of the Home Connect server.

Symbol	Description
	The Wi-Fi home network is available and the settings in the Home Connect app are activated.
	The Wi-Fi home network is available and the settings in the Home Connect app are deactivated.
	The hob is not connected to the Home Connect server and the settings in the Home Connect app are activated.
	The hob is not connected to the Home Connect server and the settings in the Home Connect app are deactivated.
	The hob is not connected to the Wi-Fi home network and the settings in the Home Connect app are activated.
	No Wi-Fi connection is available and the settings in the Home Connect app are deactivated.
	Remote maintenance is carried out and a Wi-Fi connection is available.
	Remote maintenance is carried out and no Wi-Fi connection is available.

24.5 Changing settings via the Home Connect app

You can use the Home Connect app to change the settings for the cooking zones and send them to the hob.

Requirements

- The hob is connected to the Wi-Fi and to the Home Connect app.
- In order to set the hob via the Home Connect app, the basic setting "Setting via the app" must be switched on. The basic setting is switched on on delivery. If the option for the transmission of settings has been deactivated, only the hob's operating statuses will be displayed in the Home Connect app.
- ▶ Select the setting in the Home Connect app and send it to the hob.
Follow the instructions in the Home Connect app. Settings that you send from the Home Connect app to the hob must be confirmed on the hob.
- ✓ If cooking settings are transmitted to a cooking zone, the display shows a confirmation message.

24.6 Software update

Your appliance's software can be updated using the software update function, e.g. for the purposes of optimisation, troubleshooting or security updates.

To do this, you must be a registered Home Connect user, have installed the app on your mobile device and be connected to the Home Connect server. As soon as a software update is available, you will be informed via the Home Connect app and will be able to start the software update via the app. Once the update has been successfully downloaded, you can start installing it via the Home Connect app if you are in your home network (Wi-Fi). The Home Connect app informs you once installation is successful.

Notes

- The software update consists of two steps.
 - The first step is the download.
 - The second step is the installation on your appliance.
- You can continue to use your appliance as normal while updates are downloading. Depending on your personal settings in the app, software updates can also be set to download automatically.
- Installation takes a few minutes. You cannot use your appliance during installation.
- We recommend that you install security updates as soon as possible.

24.7 Remote diagnostics

Customer Service can use Remote Diagnostics to access your appliance if you contact them, have your appliance connected to the Home Connect server and if Remote Diagnostics is available in the country in which you are using the appliance.

Tip: For further information and details about the availability of Remote Diagnostics in your country, please visit the service/support section of your local website: www.home-connect.com.

24.8 Data protection

Please see the information on data protection.

The first time your appliance is registered on a home network connected to the Internet, your appliance will transmit the following types of data to the Home Connect server (initial registration):

- Unique appliance identification (consisting of appliance codes as well as the MAC address of the installed Wi-Fi communication module).
- Security certificate of the Wi-Fi communication module (to ensure a secure data connection).
- The current software and hardware version of your appliance.
- Status of any previous resetting to factory settings.

This initial registration prepares the Home Connect functions for use and is only required when you want to use the Home Connect functions for the first time.

Note: Please note that the Home Connect functions can only be utilised with the Home Connect app. Information on data protection can be retrieved in the Home Connect app.

25 Hob-based hood control

If the hob and the extractor hood are Home Connect-compatible, connect the appliances in the Home Connect app. To do this, connect the two appliances to Home Connect and follow the instructions in the app.





Notes

- Using the controls on the extractor hood always takes priority. It is not possible to use the hob-based hood control during this time.
- You can only connect to the extractor hood via the Home Connect app. Other connection routes are no longer supported.

25.1 Resetting Home Connect settings

If you have problems connecting your appliance to the WLAN home network (Wi-Fi) or if you want to log your appliance onto a different WLAN home network (Wi-Fi), you can reset the Home Connect settings.

Note: If you reset the Home Connect settings, the connection to any extractor hood will also be terminated.

1. Touch  to open the basic settings.
2. Navigate through the entries and touch the  "Hood control" setting.
3. Select  "Disconnect hood control" and press  to confirm.

25.2 Controlling the extractor hood via the hob

In the basic settings for your hob, you can adjust the behaviour of your extractor hood depending on whether the hob or individual cooking zones are switched on or off.

You can select other settings using the controls on the hob.



Setting the fan

1. Touch  in the main screen.
2. Select a fan setting in the settings area.
You can select the following settings:

25.3 Overview of the hood control settings

In the basic settings for your hob, you can adjust the behaviour of your extractor hood depending on whether the hob or individual cooking zones are switched on or off.

The display shows the settings only when the appliance has been connected to the extractor hood.

Setting ¹	Selection	Description
	Automatic control	You can set the fan setting at which the extractor hood starts when you switch on the hob.
	Run-on function	You can set whether/how the continues to run when you switch off the hob.
	Brightness	You can set the brightness at which the lighting for the extractor hood switches on automatically with the hob.

¹ Depending on the appliance specifications



0	Fan off.
1, 2, 3	Fan settings: Low, Medium, High
»	Intensive mode
Depending on the selected setting for the fan control, the following options are displayed:	
A	Automatic mode
	Fan run-on
U	Unknown mode

- ✓ The selected fan setting appears on the main screen next to the  symbol.

Switching off the fan

- ▶ Select fan setting 0.

Switching on automatic mode

1. Touch  in the main screen.
 2. Select the  "Hood control" option.
 3. Select the A "Automatic" option.
- ✓ Depending on how the extractor hood sensor is configured, the fan will start automatically when the appliance detects smoke.



Note: You can find more information about this in the instruction manual for the extractor hood.

Switching off automatic mode

1. Touch  in the main screen.
2. Select a different fan setting.

Setting the hood lighting

You can switch the hood lighting on and off using the control panel of the hob.

1. Touch  in the main screen.
 2. Select the  "Brightness" option.
 3. Select a brightness level.
- ✓ Depending on the basic settings you have selected, the light is automatically switched on or off when the hob is switched on or off.

Setting ¹	Selection	Description
☼	Automatic light off	You can set whether the lighting for the extractor hood switches off automatically with the hob.
⊗	Disconnecting the hood control	With this setting, you reset the saved connections to the Wi-Fi or go back to the extractor hood.

¹ Depending on the appliance specifications

26 Cleaning and servicing

To keep your appliance working efficiently for a long time, it is important to clean and maintain it carefully.

26.1 Cleaning products

You can obtain suitable cleaning products and glass scrapers from customer service, a retailer or the online shop www.gaggenau.com.

ATTENTION!

Unsuitable cleaning products may damage the surfaces of the appliance.

- ▶ Never use unsuitable cleaning products.
- ▶ Do not use cleaning products while the hob is still hot. This may cause marks on the surface.

Unsuitable cleaning products

- Undiluted detergent
- Detergent intended for dishwashers
- Abrasive cleaning products
- Aggressive cleaning products such as oven spray or stain remover
- Abrasive sponges
- High-pressure or steam jet cleaners

26.2 Cleaning the hob

Clean the hob after every use to stop cooking residues from getting burnt on.

Requirement: The hob must be cold. Do not allow the hob to cool down if it has sugar stains, rice starch, plastic or aluminium foil on it.

1. Remove heavy soiling using a glass scraper.
2. Clean the hob with a cleaning agent for glass ceramic.
Follow the cleaning instructions on the packaging of the cleaning agent.

Tips

- You can achieve good cleaning results using a special sponge for glass ceramic.
- If you keep the base of the cookware clean, the hob surface remains in a good condition.

26.3 Cleaning the hob surround

If the hob frame is dirty or stained after use, clean this.

Note: Do not use a glass scraper.

1. Clean the hob frame with hot soapy water and a soft cloth.
Wash new sponge cloths thoroughly before use.
2. Dry with a soft cloth.

27 FAQs

27.1 Using the appliance

Question	Answer
No image appears on the display panel.	<ul style="list-style-type: none"> ▪ The brightness is not set correctly. Look at the the display from above and set the brightness in the basic settings. You can find additional information about this setting in the section entitled → "Basic settings", Page 23.
The main display shows a warning message and a signal tone sounds.	<ul style="list-style-type: none"> ▪ Remove liquids or food residue from the control panel. Remove any objects from the control panel. You can find out how to deactivate the audible signal in the "Basic settings" section. → Page 23

27.2 Noises

Question	Answer
Why can I hear noises while I'm cooking?	<ul style="list-style-type: none"> Noises may be generated while using the hob depending on the base material of the cookware. These noises are normal for induction technology. They do not indicate that there is a fault.
Possible noises	<ul style="list-style-type: none"> A deep humming noise similar to a transformer: Occurs when cooking at a high power level. This noise disappears or becomes quieter when you reduce the power level. A deep hum: The cookware may be too small or not suitable for induction cooking. Move the cookware to a different position on the cooking surface or use a larger item of cookware. A quiet whistling noise: This can be heard when the cookware is empty. This noise disappears when you add water or food to the cookware. Crackling: This noise occurs when the cookware is made from different multilayer materials, or if you use cookware of different sizes and different materials. The loudness of the noise can vary depending on the quantity of food being cooked or the cooking method. Loud whistling noises: These may arise if you are operating two cooking zones at the same time and at the maximum power level. These whistling noises disappear or become quieter when you reduce the power level. Fan noises: The hob is equipped with a fan that switches on automatically at high temperatures. The fan may also continue to run after you have switched the hob off if the temperature measured is still too high. Clicking: Occasional clicking when activating or moving an item of cookware is completely normal. Now and again, other completely random noises that have nothing to do with the cookware may occur.

27.3 Cookware

Question	Answer
Which cookware is suitable for the induction hob?	<ul style="list-style-type: none"> You can find information on which cookware is suitable for induction cooking in the "Suitable cookware" section. → <i>Page 5</i>
Why is the hob not heating?	<ul style="list-style-type: none"> Ensure that the cookware is suitable for use with an induction hob. You can find more information on the type, size and positioning of suitable cookware in the "Suitable cookware" section. → <i>Page 5</i>
Why is it taking so long for the cookware to heat up or why is it not heating up sufficiently despite being on a high power setting?	<ul style="list-style-type: none"> Ensure that the cookware is suitable for use with an induction hob. You can find more information on the type, size and positioning of suitable cookware in the "Suitable cookware" section. → <i>Page 5</i>
The cookware display on the touch display does not correspond to the size or shape of the cookware.	<ul style="list-style-type: none"> There are more than 8 items of cookware on the cooking surface. The cookware is too small: We recommend a diameter of 90 to 340 mm. Use a bigger item of cookware or cookware that is suitable for induction cooking. Alternatively, move the cookware to a different position on the cooking surface. You can find information on which cookware is suitable for induction cooking in the "Suitable cookware" section. → <i>Page 5</i>
An item of cookware that is not displayed on the touch display is located on the cooking surface.	<ul style="list-style-type: none"> There are more than 8 items of cookware on the cooking surface. The cookware is too small: We recommend a diameter of 90 to 340 mm. Use a bigger item of cookware or cookware that is suitable for induction cooking. Alternatively, move the cookware to a different position on the cooking surface. You can find information on which cookware is suitable for induction cooking in the "Suitable cookware" section. → <i>Page 5</i>
Two items of cookware are on the cooking surface, but these are shown on the touch display as one item of cookware.	<ul style="list-style-type: none"> If you place two items of cookware very close together on the cooking surface, this may appear on the touch display as one item of cookware. Move the items of cookware further away from each other until they are shown as two individual items of cookware on the touch display.

Question	Answer
One item of cookware is on the cooking surface, but two or more are shown on the touch display.	<ul style="list-style-type: none"> ▪ The base of the cookware may be deformed or embossed, or the cookware is not suitable for induction cooking. Check the flatness of the cookware and place it back on the cooking surface. You can find information on which cookware is suitable for induction cooking in the "Suitable cookware" section. → <i>Page 5</i>
You cannot use any cookware that is on the cooking surface.	<ul style="list-style-type: none"> ▪ You can place up to 8 items of cookware on the cooking surface but only up to 6 evenly distributed items can be used at the same time. You can find more information on the type, size and positioning of suitable cookware in the "Suitable cookware" section. → <i>Page 5</i> ▪ You can cook with up to 3 items of cookware on each side at the same time. If an item of cookware is located in the centre of the cooking surface or the cookware is too big, this restricts the number of active items of cookware. You can find more information on the type, size and positioning of suitable cookware in the "Suitable cookware" section. → <i>Page 5</i> ▪ One of the items of cookware is not suitable for induction cooking. ⊖ appears beside the unsuitable cookware on the touch display. You can find more information on the type, size and positioning of suitable cookware in the "Suitable cookware" section. → <i>Page 5</i> ▪ The appliance has exceeded its maximum power consumption or the Power limitation function has been switched off. Check the installation and set the Power limitation function correctly.
The power level cannot be increased.	<ul style="list-style-type: none"> ▪ The appliance has exceeded its maximum power consumption or the Power limitation function has been switched off. Change the distribution of the cookware on the cooking surface. Check the installation and set the Power limitation function correctly. You can find out how to do this in the "Basic settings" section → <i>Page 23</i>
The cooking sensor is not available.	<ul style="list-style-type: none"> ▪ The appliance has exceeded its maximum power consumption or the Power limitation function has been switched on. Switch off or reduce the power levels for the other item of cookware. Change the distribution of the cookware on the cooking zone. Check the installation and set the Power limitation function correctly. Power limitation → <i>Page 24</i>
Cooking times are longer if you use the appliance intensively.	<ul style="list-style-type: none"> ▪ This may be due to the fact that internal safety mechanisms are preventing the cooker from overheating. Try to change the position of the cookware.
Bubbles are forming with an uneven distribution within the cookware.	<ul style="list-style-type: none"> ▪ Depending on the selected power level, type of cookware or the combination with other cookware, bubbles may form unevenly. However, this has no effect on the temperature or the cooking process. You can find information on which cookware is suitable for induction cooking in the "Suitable cookware" section. → <i>Page 5</i>

27.4 Cleaning

Question	Answer
How can I clean the hob?	<ul style="list-style-type: none"> ▪ You can achieve the best results by using special glass-ceramic cleaning products. Do not use harsh or abrasive cleaning products, dishwasher detergent (concentrated) or scouring pads. You can find more information about this under → "<i>Cleaning and servicing</i>", <i>Page 27</i>.

27.5 Home network

Question	Answer
Why can I not connect the hob to the WiFi after the WPS button has been pressed on the router?	<ul style="list-style-type: none"> ▪ Press the WPS button on the router within 2 minutes after selecting the connect automatically option. Once this time has elapsed, start the connection set-up again. If the problems persist, restore the appliance to the factory settings. You can find out how to do this in the "Basic settings" section → <i>Page 23</i>.
Why is my mobile device not logging into the Home Connect network?	<ul style="list-style-type: none"> ▪ Connect to the Home Connect SSID and the Home Connect key. Ensure that all characters have been entered correctly and attention has been paid to upper-case and lower-case letters.

28 Troubleshooting

You can rectify minor faults on your appliance yourself. Read the troubleshooting information before contacting after-sales service. This will avoid unnecessary costs.

⚠ WARNING – Risk of injury!

Improper repairs are dangerous.

- ▶ Repairs to the appliance should only be carried out by trained specialist staff.
- ▶ If the appliance is defective, call Customer Service. → "*Customer Service*", *Page 33*

⚠ WARNING – Risk of electric shock!

Improper repairs are dangerous.

- ▶ Repairs to the appliance should only be carried out by trained specialist staff.
- ▶ Only use genuine spare parts when repairing the appliance.
- ▶ If the power cord or the appliance power cable of this appliance is damaged, it must be replaced with a special power cord or special appliance power cable, which is available from the manufacturer or its Customer Service.

28.1 Warnings

If a problem occurs, instructions, warnings or error messages are shown automatically on the display. To eliminate the problem, follow the instructions on the touch display. If required, contact customer service and specify the exact fault code.

Notes

- If an error occurs, the appliance does not switch to standby mode.
- In order to protect the appliance's electronic parts from overheating or surge currents, the hob may temporarily reduce the power level.

28.2 Information on the display panel

Fault	Cause and troubleshooting
The hob cannot be switched on.	The power supply has been disconnected. <ul style="list-style-type: none"> ▶ Use other electrical appliances to check whether there has been a power failure.
	The appliance has not been connected as shown in the circuit diagram. <ul style="list-style-type: none"> ▶ Connect the appliance in accordance with the circuit diagram.
	Electronics fault <ul style="list-style-type: none"> ▶ If you are unable to rectify the fault, inform the technical after-sales service.
The touchscreen display is not responding or has frozen.	The control panel is wet or an object is covering it. <ul style="list-style-type: none"> ▶ Dry the control panel or remove the object.
The cooking zone's power level cannot be increased.	The hob's total power output has been limited. <ul style="list-style-type: none"> ▶ Change the total power under "Maximum power consumption" in the basic settings. ▶ If a very large item of cookware is being used, this may have an effect on the maximum power level for that half of the hob. Place the cookware back on the hob.
Audible signal	There is something on the touch display. <ol style="list-style-type: none"> 1. Remove the object and reconfigure the hob settings. 2. Do not place hot cookware on the control panel.

Fault	Cause and troubleshooting
The hob is responding in an unusual manner or can no longer be operated correctly.	A fault has occurred in the electronics. <ol style="list-style-type: none"> 1. Switch off the appliance using the mains fuse or the circuit breaker in the fuse box. 2. Wait a few seconds before reconnecting the appliance.
One or all cooking zones have been automatically switched off.	The electronics have overheated and one or all of the cooking zones have been switched off. There is hot cookware in the vicinity of the control panel. The cooking zone has been switched off to protect the electronics. The cooking zone has overheated and has been switched off to protect the work surface.
The transfer settings function cannot be activated.	Electronics fault <ul style="list-style-type: none"> ▶ Touch any button to confirm the fault display. You can continue to cook as normal without using the Transfer settings function. Contact customer service.
<i>E7010</i>	The hob is unable to connect to your home network or the extractor hood. <ol style="list-style-type: none"> 1. Acknowledge the fault display by touching any of the sensor fields. You can cook as usual without a connection. 2. If the problem persists, contact our technical after-sales service.
<i>E8202</i>	The cooking sensor has overheated and the cooking zone has been switched off. <ul style="list-style-type: none"> ▶ Wait until the cooking sensor has cooled down sufficiently before activating the function again.
<i>E8203</i>	The cooking sensor has overheated and all of the cooking zones have been switched off. <ul style="list-style-type: none"> ▶ When you are not using the cooking sensor, remove it from the cookware and keep it away from other cooking zones or heat sources. Switch on the cooking zones.
<i>E8204</i>	The battery in the cooking sensor is almost flat. The next time you cook, you may be interrupted by the battery running out. <ul style="list-style-type: none"> ▶ Replace the 3 V CR2032 battery. For more information, see the section entitled → <i>"Replacing the battery", Page 19</i>
<i>E8205</i>	The connection to the cooking sensor has been broken. <ul style="list-style-type: none"> ▶ Switch off the function and reactivate it.
<i>E8206</i>	The cooking sensor is broken/faulty. <ul style="list-style-type: none"> ▶ Contact the technical after-sales service.
The wireless cooking sensor display does not light up.	The wireless cooking sensor is not responding and the display does not light up. <ul style="list-style-type: none"> ▶ Replace the 3 V CR2032 battery. For more information, see the section entitled → <i>"Replacing the battery", Page 19</i>. ▶ If this does not solve the problem, press and hold the symbol on the cooking sensor for 8–10 seconds and then reconnect the cooking sensor to the hob. You can find more information in the section entitled → <i>"Connecting the wireless cooking sensor", Page 18</i>. ▶ If the problem persists, contact our technical after-sales service.
The display on the sensor flashes twice.	The battery in the cooking sensor is almost flat. The next time you cook, you may be interrupted by the battery running out. <ul style="list-style-type: none"> ▶ Replace the 3 V CR2032 battery. For more information, see the section entitled → <i>"Replacing the battery", Page 19</i>.
The display on the sensor flashes three times.	The connection to the cooking sensor has been broken. <ul style="list-style-type: none"> ▶ Press and hold the symbol on the cooking sensor for 8–10 seconds and then reconnect the cooking sensor to the hob.
<i>E 9000/E9010</i>	The operating voltage is incorrect and outside of the normal operating range. <ul style="list-style-type: none"> ▶ Contact your energy supplier.
<i>U400/E9011</i>	The hob is not connected correctly. <ul style="list-style-type: none"> ▶ Disconnect the hob from the mains. Connect the hob in accordance with the circuit diagram.
The cooking zones do not heat up, and  is displayed.	Demo mode is activated. <ol style="list-style-type: none"> 1. Disconnect the hob from the mains and, after a few seconds, reconnect it. 2. Deactivate demo mode in the basic settings within the next three minutes.

28.3 Normal noises from your appliance

An induction hob may sometimes cause noises or vibrations, such as buzzing, crackling, hissing noises, fan noises or rhythmic noises.

29 Disposal

29.1 Disposing of old appliance

Valuable raw materials can be reused by recycling.

1. Unplug the appliance from the mains.
2. Cut through the power cord.
3. Dispose of the appliance in an environmentally friendly manner.

Information about current disposal methods are available from your specialist dealer or local authority.



This appliance is labelled in accordance with European Directive 2012/19/EU concerning used electrical and electronic appliances (waste electrical and electronic equipment - WEEE). The guideline determines the framework for the return and recycling of used appliances as applicable throughout the EU.

29.2 Disposing of batteries

Batteries should be recycled in an environmentally friendly manner. Do not dispose of the batteries in the household rubbish.

- ▶ Dispose of batteries in an environmentally friendly manner.



According to the European Guideline 2006/66/EC, defective or used battery packs/batteries, must be collected separately and disposed of in an environmentally correct manner.

30 Declaration of Conformity

BSH Hausgeräte GmbH hereby declares that the appliance with Home Connect functionality conforms to the basic requirements and other relevant provisions of Directive 2014/53/EU.

A detailed RED Declaration of Conformity can be found online at www.gaggenau.com among the additional documents on the product page for your appliance.



Hereby, BSH Hausgeräte GmbH declares that the appliance with Home Connect functionality is in compliance with relevant statutory requirements.¹

A detailed Declaration of Conformity can be found online at www.gaggenau.com/gb among the additional documents on the product page for your appliance.¹



2.4 GHz band (2400–2483.5 MHz): Max. 100 mW
 5-GHz band (5150–5350 MHz + 5470–5725 MHz): max. 50 mW

	BE	BG	CZ	DK	DE	EE	IE	EL	ES
	FR	HR	IT	CY	LI	LV	LT	LU	HU
	MT	NL	AT	PL	PT	RO	SI	SK	FI
	SE	NO	CH	TR	IS	UK (NI)			

5 GHz WLAN (Wi-Fi): For indoor use only.

AL	BA	MD	ME	MK	RS	UK	UA
----	----	----	----	----	----	----	----

5 GHz WLAN (Wi-Fi): For indoor use only.

¹ Only applies to Great Britain

30.1 Statement of Compliance for Great Britain

Product type

This statement of compliance covers the products described in this information for use whose model identifier group is seen on the title page. The full model identifier is made up of the characters before the slash in the product number (E no.) which can be found on the rating plate. Alternatively, you can also find the model identifier in the first line of the UK Energy Label.

Name and address of manufacturer

BSH Hausgeräte GmbH, Carl-Wery-Strasse 34, 81739 München, Germany

This statement of compliance is prepared by the manufacturer.

The manufacturer, BSH Hausgeräte GmbH deems that it has complied with

- provision 5.1-1 of ETSI EN 303 645 v2.1.1 and, where relevant, provision 5.1-2 of ETSI EN 303 645 v2.1.1;
- provision 5.2-1 of ETSI EN 303 645 v2.1.1;
- provision 5.3-13 of ETSI EN 303 645 v2.1.1.

Support period

BSH Hausgeräte GmbH will provide security updates that are necessary to maintain the main functions free of charge until at least 28/02/2034.

31 Customer Service

Function-relevant genuine spare parts according to the corresponding Ecodesign Order can be obtained from Customer Service for a period of at least 10 years from the date on which your appliance was placed on the market within the European Economic Area.

Note: Under the terms of the manufacturer's warranty the use of Customer Service is free of charge.

Detailed information on the warranty period and terms of warranty in your country is available from our after-sales service, your retailer or on our website.

If you contact Customer Service, you will require the product number (E-Nr.) and the production number (FD) of your appliance.

The contact details for Customer Service can be found in the enclosed Customer Service directory or on our website.

31.1 Product number (E-Nr.) and production number (FD)

You can find the product number (E-Nr.) and the production number (FD) on the appliance's rating plate.

The rating plate can be found:

- on the appliance certificate.
- on the lower section of the hob.

The product number (E no.) can also be found on the glass ceramic. You can also display the customer service index (KI) and the production number (FD) in the basic settings. → *Page 23*

Make a note of your appliance's details and the Customer Service telephone number to find them again quickly.

BSH Hausgeräte GmbH
Carl-Wery-Straße 34
81739 München, GERMANY
www.gaggenau.com

Valid within Great Britain:
Imported to Great Britain by
BSH Home Appliances Ltd.
Grand Union House
Old Wolverton Road
Wolverton, Milton Keynes
MK12 5PT
United Kingdom

GAGGENAU



9001725822 en (040412)